

RAYCHEM
TraceTek

TTDM-128 TraceTek Leak Detection Master Module

User Manual



CONTENTS

Overview	3
System Configurations	3
Quick Setup	5
Common Setup Procedures	5
Configuration Specific Setup.....	7
TTDM-128 Capabilities	10
The TraceTek TTDM-128 Network	10
Description of TraceTek Leak Detection System.....	11
TTDM-128 Features	12
Identifying TTDM-128 Features	12
The TTDM-128 Keypad.....	13
The TTDM-128 System Display.....	14
Current Event/Status Display	15
Navigating the Menu Structure	16
Main Menu Structure	17
SIM Status Menu Structure	18
SIM Status Menu	19
Modifying Settings for Individual SIM Channels.....	19
Setting Up Regions and Relays	24
SIM Relay Setup	25
Main Menu	26
Events History Log.....	26
System Status	27
General Set-up.....	28
Leak Setup.....	28
SIM Network.....	29
TTDM Network.....	31
Self-Test.....	32
Event Response	33
Leak Detection and Location Events	33
Service Events.....	34
Fault Events.....	35
Multiple Events.....	35
Maintenance	38
Investigating Leaks and Faults	39
Appendix 1 - Events Glossary	40
Appendix 2 - Connection to Other Devices	41

OVERVIEW

READ BEFORE USE

Please read these instructions carefully and keep them in a safe place (preferably close to the nVent RAYCHEM TTDM-128) for future reference. The instructions provided in this booklet must be followed carefully to ensure proper operation. If the equipment is used in a manner not specified by the manufacturer, the protection provided by the equipment may be impaired.

PREPARATION

Before operation, follow the installation instructions to ensure that each module is properly mounted and wired. If these steps have not been taken, refer to the installation documents provided for each module. To obtain this literature or for technical assistance, contact your local TraceTek distributor or visit our web site (nVent.com).



IMPORTANT: There should be a “System Map” for each sensor circuit. The system map should show the sensing cable layout with reference to readily identifiable landmarks and with actual distance measurements every 5 m (16 ft) throughout the system. The map is normally completed at the time the leak detection system is commissioned. Ensure that a copy of the system map is kept near the TTDM-128 module. If the TTDM-128 is connected to a building management system, ensure that a copy of the system map accompanies the building management system.



IMPORTANT: Throughout this manual, the examples shown use distances in meters. Later versions of software may provide new features and change certain other details. This manual documents UI software version 3.15.

SYSTEM CONFIGURATIONS

The TraceTek TTDM-128 module has many possible applications and configurations. The TTDM-128 can be configured as a stand-alone leak detection panel, or it can be used in a network of other TraceTek leak detection modules, such as the TTSIM sensor interface module, the TT-NRM network relay module, or additional TTDM-128 modules. In all cases, each TTDM-128 offers the following features and capabilities:

- Directly monitor up to 1500 m (5000 ft) of TraceTek sensor cable and point sensors.
- 2048 event memory.
- Built-in status and alarm relays.
- Optional 4-20 mA output.

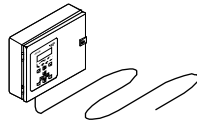

SINGLE TTDM-128 WITH SINGLE CHANNEL SYSTEM

(SEE QUICK SETUP SECTION)

- TTDM-128 with up to 1500 m (5000 ft) of TraceTek sensor cable, or a combination of sensor cable and point sensors.

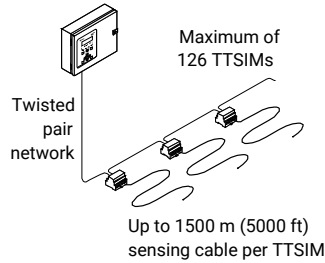

SINGLE TTDM-128 WITH NETWORK SYSTEM (MULTIPLE SIMS)

(SEE QUICK SETUP SECTION)

- A single TTDM-128 is used as the master module for a network of up to 126 additional TraceTek modules (TTSIM, TT-NRM).

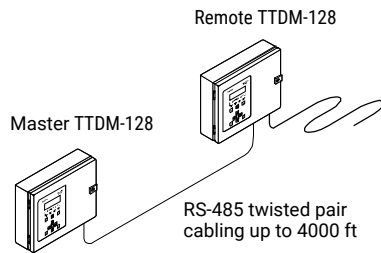

MASTER TTDM-128 WITH SINGLE REMOTE TTDM-128

(SEE QUICK SETUP SECTION)

- Master TTDM-128 monitors all conditions at the remote TTDM-128.
- Remote TTDM-128 acts like a single channel.
- Modbus interface to a host computer is only available at the Master TTDM-128 in this configuration.

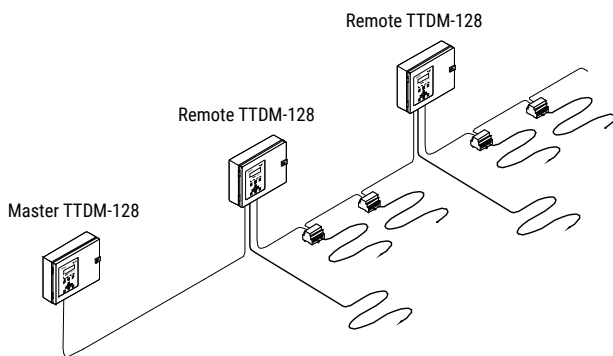

MASTER TTDM-128 WITH NETWORK SYSTEM (MULTIPLE REMOTE TTDM-128S AND SIMS)

(SEE QUICK SETUP SECTION)

- The same as the single TTDM-128 network system, except with additional TTDM-128's acting as remote modules, and one TTDM-128 acting as Master.
- Additional TTSIM and TT-NRM modules can be installed on the network, up to a total of 127 modules (including TTDM-128's).
- Modbus interface to a host computer is only available at the Master TTDM-128 in this configuration.

COMMON SETUP PROCEDURES

All modules, cables and sensors should be installed in accordance with their installation instructions prior to performing the setup procedures.

BASIC TTDM-128 SETUP (FOR ALL CONFIGURATIONS)

- Power up the TraceTek system. Wait while the TTDM-128 completes its self test and network initialization process.
- With the TTDM-128 on the Current Event/Status display, press the **Menu** key.
- Using the Down arrow key, scroll to General Setup and press **Enter**.
 - Set the Time and Date (adjust values as necessary using the arrow keys, then press **ENTER**).
 - Select the desired language.
- Press **MENU** to return to the Current Event/Status display.

SETTING NVENT RAYCHEM TRACETEK TTSIM ADDRESSES ON NETWORK SYSTEMS

If your system includes TTSIM modules, their network addresses must be set to unique values in the range from 02 to 127 (address 01 is the default address of the TTDM-128's internal Sensor Interface board). If TT-NRM network relay modules are installed, the TTSIM addresses must be different than any TT-NRM addresses.

- With the TTDM-128 on Current Event/Status display, press **MENU**.
- Use the **DOWN** arrow key to select SIM Network, then press **ENTER**.
- For each TTSIM (perform complete procedure before continuing to next TTSIM):
 - Place the TTSIM configuration jumper in the CFG position (see TTSIM Installation Instructions).
 - With the TTDM-128 in the SIM Network menu, use the **UP** and **DOWN** arrow keys to select Set SIM Address, then press **ENTER**.
 - Press **ENTER** again, use the arrow keys to input the new TTSIM address, then press **ENTER**.
 - Return the TTSIM configuration jumper to the normal operating position (see TTSIM Installation Instructions).
 - Press **Esc** (TTDM should display SIMxxx added). Then, press **Esc** again.
- Press **MENU** to return the TTDM-128 to Current Event/Status Display mode.

TIME SAVING HINT

- If the space to the right is blank, press the right arrow to duplicate the last letter entered
- Use the Reset key to jump between letters, numbers and blank

CHANGING SIM CHANNEL ID TAG

Each leak detection channel (TTDM-128 or TTSIM) can be given a unique alpha-numeric identification tag. To change the ID tag of a channel:

- With the TTDM-128 in normal operating mode and displaying the status of the desired leak detection channel, press the **Down** arrow key:
 - Use the **DOWN** arrow key to scroll to select ID, then press **ENTER**.
 - Using the **Left** and **Right** arrow keys to select the character position, and the **Up** and **Down** arrow keys to change the letters and numbers, enter the desired ID tag. Press **Enter** when finished.
 - Press **MENU** to return to the Current Event/Status Display.

CHANGING SIM CHANNEL UNITS

The unit of measure for circuit length can be changed individually by channel, or for all channels.

TO CHANGE UNITS FOR AN INDIVIDUAL CHANNEL:

- With the TTDM-128 in the Current Event/Status Display and displaying the status of the desired leak detection channel, press the **DOWN** arrow key.
- Use the **DOWN** arrow key to select TestLength, then press **ENTER**.
- Use the **UP/DOWN** arrow keys to select the desired units (feet, meters or zones) then press **ENTER**.
- Press **MENU** to return to the Current Event/Status Display.

To change units for all channels at once:

- A password is required to access the Special menu and change all units. To input the password:
 - With the TTDM-128 in the Current Event/Status Display press the **MENU** key.
 - Use the **DOWN** arrow key to select General Setup, then press **ENTER**.
 - Use the **DOWN** arrow key to select Password, then press **ENTER**.
 - Use the arrow keys to input the password 04000, then press **ENTER**.
- Press **Esc**.
- With the display showing the General Setup menu, use the **DOWN** arrow key to select Special, then press **ENTER**.
- Use the **DOWN** arrow key to select Set All Units, then press **ENTER**.
- Use the **UP/DOWN** arrow keys to select the desired units (feet, meters or zones) then press **ENTER**.
- Press **MENU** to return to the Current Event/Status Display.

SET HOST PORT PARAMETERS

For TTDM-128's that are connected to a host computer, DCS or building management system, the host port parameters must be set in the TTDM network menu.

- Set toggle switch SW2 (located on underside of UI board) to RS485 position (see feature 26 on Internal View of TTDM-128 Features diagram).
- With the TTDM-128 in the Current Event/Status display, press **MENU**.
- Use the **DOWN** arrow key to select TTDM Network, then press **ENTER**.
- Use the **DOWN** arrow key to select the desired parameter, then press **ENTER**. If asked for a password, input 00010 and press **ENTER**. The parameters that can be changed are:
 - Baud: select host port baud rate.
 - Modem: Define modem dialing strings (if used).
 - 485 Address: Set the TTDM's Modbus address.
 - TTDM: Select the appropriate mode. The password for this parameter is 04000. See the TTDM Network section for more selection information.



IMPORTANT: For communication with automation systems, PC's and other host systems, set the port to Auto. (Auto is the most common setting. See detailed discussion of other settings in Main Menu, TTDM Network section.)

CONFIGURATION SPECIFIC SETUP

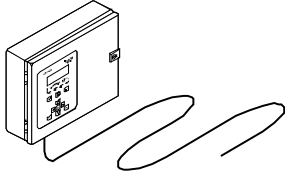

SINGLE TTDM-128 WITH SINGLE CHANNEL SYSTEM

- Perform Basic TTDM-128 Setup. (SEE QUICK SETUP SECTION.)
- Assign the leak detection channel tag if required.
- Perform the Host Port Setup if required. (SEE QUICK SETUP SECTION.)

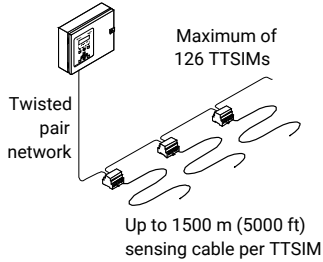

SINGLE TTDM-128 WITH NETWORK SYSTEM (MULTIPLE SIMS)

- Perform Basic TTDM-128 Setup. (SEE QUICK SETUP SECTION.)
- Perform the Host Port Setup if required. (SEE QUICK SETUP SECTION.)
- Assign a unique address to each TTSIM.
- Change the leak detection channel ID tags for each TTSIM if required.

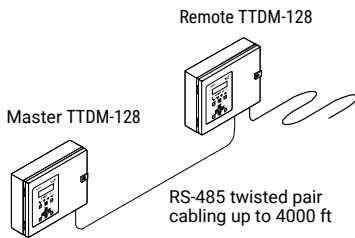

MASTER TTDM-128 WITH SINGLE REMOTE TTDM-128

One of the TTDM-128s must be selected as the Master TTDM-128, and operate in AUTO mode. The other TTDM-128 will operate in REMOTE mode.

Before powering up the system:

- Connect the RS-485 host port (J13) of the Remote TTDM-128 to the TraceTek Network port (J10) of the Master TTDM-128. Observe correct polarity.

You can now power up the Remote TTDM-128 and proceed with setup as follows:

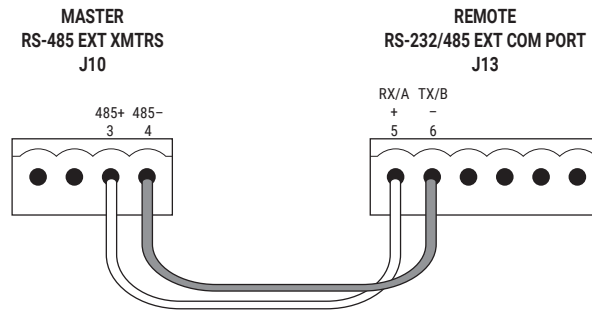

AT THE REMOTE TTDM-128

- Perform Basic TTDM-128 Setup. (SEE QUICK SETUP SECTION.)
- Change TTDM-128 Internal SI board address to unique value. (Note that each remote TTDM-128 and SIM must have a unique address between 02 and 127).
- Assign a unique address to each TTSIM.
- Assign the leak detection channel tag (SIM ID) if required.
- Set toggle switch SW2 (located on underside of UI board) to RS485 position (see feature 26 on Internal View of TTDM-128 Features diagram).
- Go to TTDM network menu. Set the parameters as follows:
 - Set baud rate to 9600.
 - Set TTDM mode to Remote.

AT THE MASTER TTDM-128

You can now power up the Master TTDM-128 and proceed with setup as follows:

- Perform Basic TTDM-128 Setup. (SEE QUICK SETUP SECTION.)
- Check that the TTDM mode is set to Auto, and internal SI board address is set to 01.
- Change the Communication Timeout parameter:
 - With the TTDM-128 in the Current Event/Status display, press **MENU**.
 - Use the **DOWN** arrow key to select General Setup, then press **ENTER**.
 - Use the **DOWN** arrow key to select Password, then press **ENTER**.
 - Input the value 04000, then press **ENTER** followed by **ESC**.
 - Use the **DOWN** arrow key to select Special, then press **ENTER**.
 - Use the **DOWN** arrow key to select Comm Timeout, then press **ENTER**.
 - Use the arrow keys to input the value 300 ms, then press **ENTER**.
 - Press **MENU** to return to the Current Event/Status display.
- Initialize the SIM network (see SIM network section).
- Change the leak detection channel ID tags to match what was set at the Remote TTDM-128.

MASTER TTDM-128 WITH NETWORK SYSTEM (MULTIPLE REMOTE TTDM-128'S AND SIMS)

One of the TTDM-128s must be selected as the master TTDM-128 and operate in "Auto" mode; the remaining TTDM-128's in the network will operate in "remote" mode.

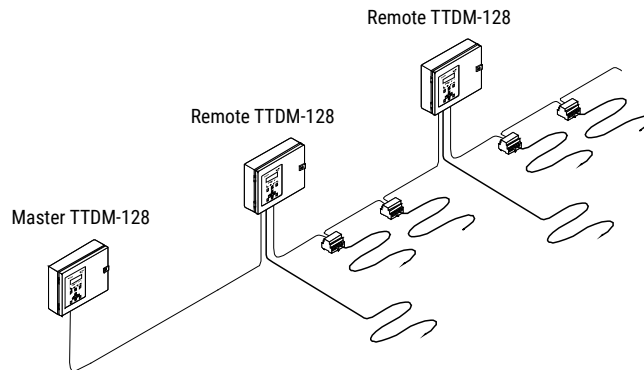

Before powering up the system:

Connect the RS485 host port (J13) of the first Remote TTDM-128 to the TraceTek network port (J10) of the Master TTDM-128. All other Remote TTDM-128s are interconnected using their respective RS485 host port (J13). Observe correct polarity.

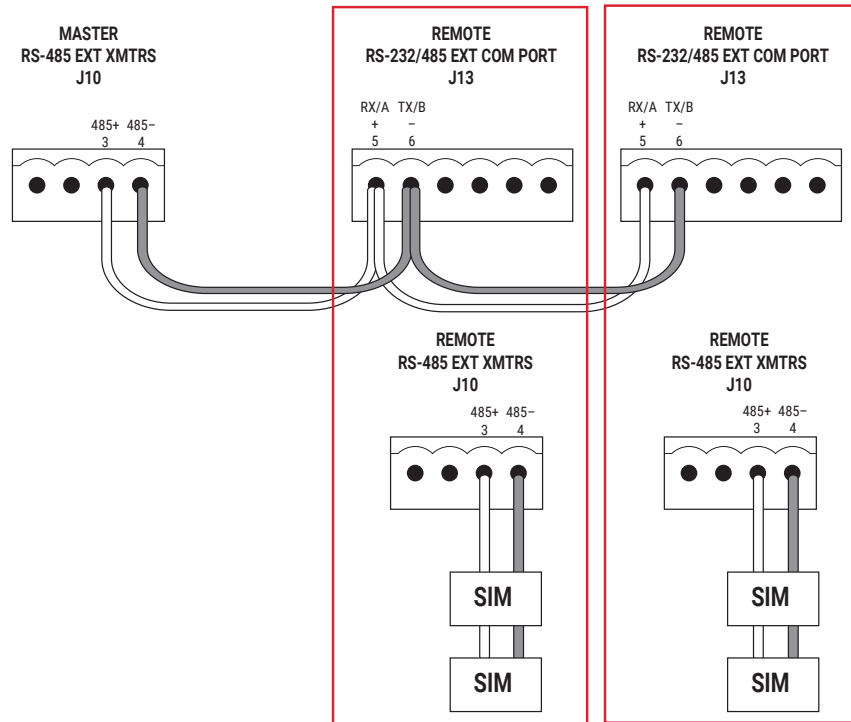

You can now power up the Remote TTDM-128 and proceed as follows:

AT EACH REMOTE TTDM-128:

- Perform Basic TTDM-128 Setup. (SEE QUICK SETUP SECTION.)
- Change TTDM-128 Internal SI board address to unique value. (Note that each remote TTDM-128 and SIM must have a unique address between 02 and 127).
- Assign a unique address to each TTSIM.
- Assign the leak detection channel tag (SIM ID) if required.
- Set toggle switch SW2 (located on underside of UI board) to RS485 position (see feature 26 on Internal View of TTDM-128 Features diagram).
- Go to TTDM network menu. Set the parameters as follows:
 - Set baud rate to 9600.
 - Set TTDM mode to Remote.
- Initialize the SIM Network (see SIM Network section).

You can now power up the Master TTDM-128 and proceed as follows:

AT THE MASTER TTDM-128:

- Perform Basic TTDM-128 Setup. (SEE QUICK SETUP SECTION.)
- Check that the TTDM mode is set to Auto, and internal SI board address is set to 01.
- Change the Communication Timeout parameter:
 - With the TTDM-128 in the Current Event/Status display, press **MENU**.
 - Use the **DOWN** arrow key to select General Setup, then press **ENTER**.
 - Use the **DOWN** arrow key to select Password, then press **ENTER**.
 - Input the value 04000, then press **ENTER** followed by **ESC**.
 - Use the **DOWN** arrow key to select Special, then press **ENTER**.
 - Use the **DOWN** arrow key to select Comm Timeout, then press **ENTER**.
 - Use the arrow keys to input the value 300 ms, then press **ENTER**.
 - Press **MENU** to return to the Current Event/Status display.
- Initialize the SIM network (see SIM Network section).
- Change the leak detection channel ID tags to match what was set at the Remote TTDM-128.

TTDM-128 CAPABILITIES

THE TRACETEK TTDM-128 NETWORK

The TTDM-128 can directly monitor up to 1500 m (5000 ft) of TraceTek sensor cables, up to 150 TraceTek point sensors and networks of up to 126 external TraceTek modules (which can include any combination of TTSIM sensor interface modules, TT-NRM network relay modules or up to 32 additional TTDM-128's operating in Remote mode). With a fully implemented network, it is possible to monitor as much as 190 km (119 miles) of TraceTek sensor cable and provide as many as 320 discrete relays to handle a wide variety of alarm and telemetry functions.



IMPORTANT: the maximum number of TTSIMs on a network must be reduced by 4 for each TT-NRM added.

Each TTDM-128 provides:

- An internal Sensor Interface Module (SIM), capable of directly monitoring up to 1500 m (5000 ft) of sensor cable, 150 point sensors, or a combination of both cable and sensors.
- 3 alarm relays, providing status for:
 - Leak alarm
 - Service required alarm
 - System fault alarm
- Serial communication to a host computer, control system or building management system using RS-232 or RS-485 hardware and Modbus™ protocol.
- Event history log (non-volatile)
- Optional 4-20 mA output

When liquid is detected on any sensor, the TTDM-128 sounds an alarm, illuminates an LED, closes relay contacts, and displays the channel number and location of the leak on an LCD display. Each alarm event (leak, service, fault, etc.) and user action is logged into the event history file. The event history file shows the type of event and the time and date that the event occurred. This information is available to any host PLC or building automation system via an RS232 or RS485 serial connection and the Modbus protocol.

A simple system map (typically an as-built drawing of the sensor installation with reference measurements) showing where the sensors have been installed is the only field calibration requirement.

Each individual sensor circuit detects, locates, and tracks leaks independently from the other circuits in the leak detection system. There is no loss of sensitivity and no re-mapping required after an initial leak is detected.

The TTDM-128's internal SIM has been designed for use with the following TraceTek sensing cables:

- TT1000 (water)
- TT1100-OHP series (water)
- TT3000 (acids and aqueous chemicals)
- TT5000 series (liquid hydrocarbon fuels and oils)
- TT-FFS series (liquid hydrocarbon fuels and oils)
- TT5001 series (organic solvents)
- TT7000-HUV (strong mineral acids)

A variety of TraceTek Point sensors, including the TT-FLAT-PROBE and TT-MINI-PROBE, as well as contact closure devices such as float switches, can also be used with the TTDM-128.

DESCRIPTION OF TRACETEK LEAK DETECTION SYSTEM

TRACETEK SENSING CABLES

The TraceTek leak detection system is based on sensing cables that detect liquid at any point along their length. A variety of TraceTek sensing cables are available to detect different types of liquids. While multiple types of sensing cables may be used in a single sensing circuit, if different types of fluid are being monitored in the same area it may be more effective to create multiple circuits, each with dedicated sensor cable of a specific type.

COMPONENTS OF TRACETEK LOCATING SYSTEM

TraceTek leak detection is a versatile modular system, with interchangeable components that can be configured in many different ways. For more information on the products and systems available, consult the appropriate TraceTek product selection guide or your local TraceTek representative.

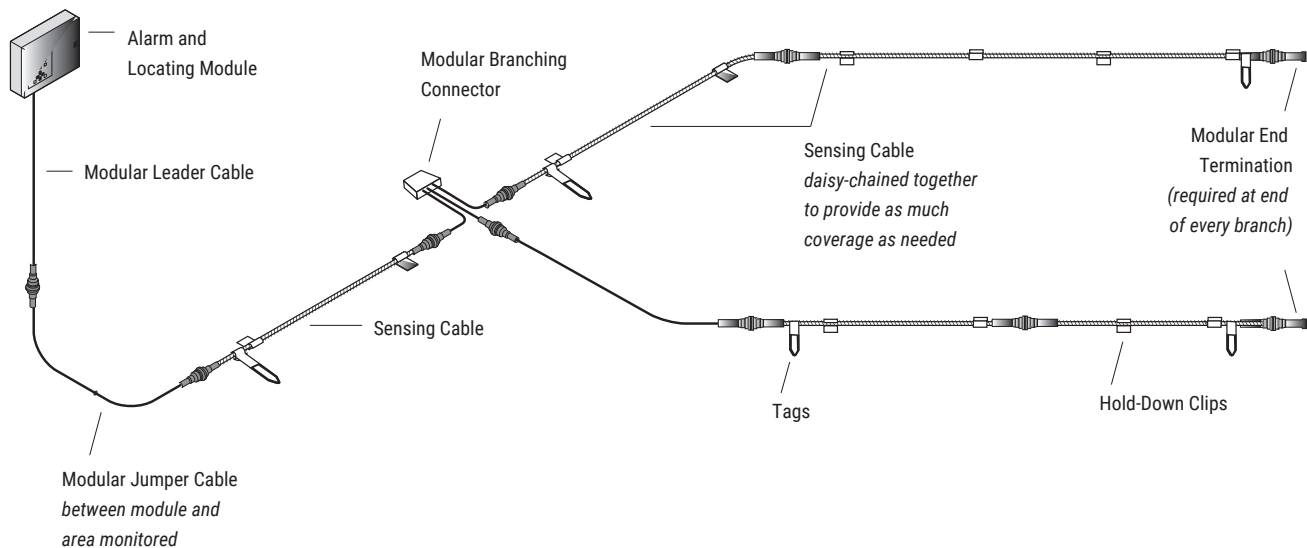

A TraceTek locating system provides distributed leak detection and location over long distances and wide areas. A TraceTek locating circuit consists of a TraceTek locating module (TTDM-128, TTSIM), sensing cable and/or point sensors, and circuit components (leader cable, jumper cables, end terminations, weighted lengths, and branching connectors) with connectors that allow components of the system to plug together.

The **weighted length** resistor simulates a 4.5 m (15 ft) length of sensing cable. Installed at the boundary between two areas of sensing cable, the weighted length allows the user to clearly identify the area where a leak has occurred.

The **branching connector** enables the sensing cable to be branched. An end **termination** completes each branch. At the branching connector, the system first counts the sensing cable along the branch (middle connector) to its end termination, before it continues with the main run. Two built-in 4.5 m (15 ft) weighted-length resistors allow the user to clearly identify the leg on which a leak has occurred.

IDENTIFYING TTDM-128 FEATURES

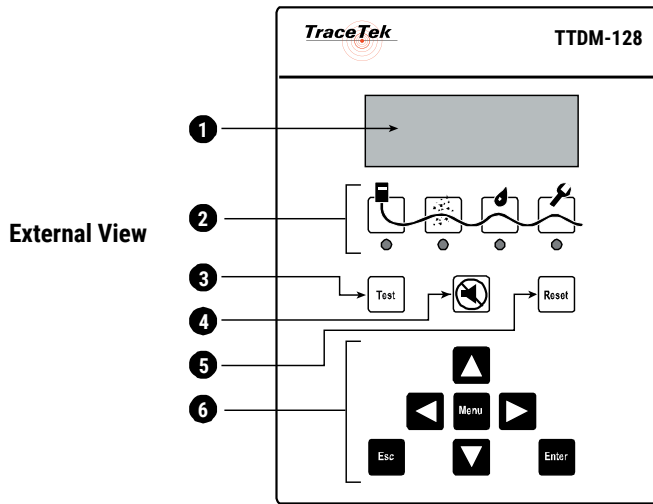

EXTERNAL VIEW

- 1 LCD display gives up-to-date information regarding the condition of the system
- 2 Icons and LEDs:
Monitoring LED - green
Service Required LED - Yellow
Leak LED - Red
Fault LED - Red
- 3 (Self) Test key
- 4 Silence key
- 5 Reset key
- 6 Menu keys

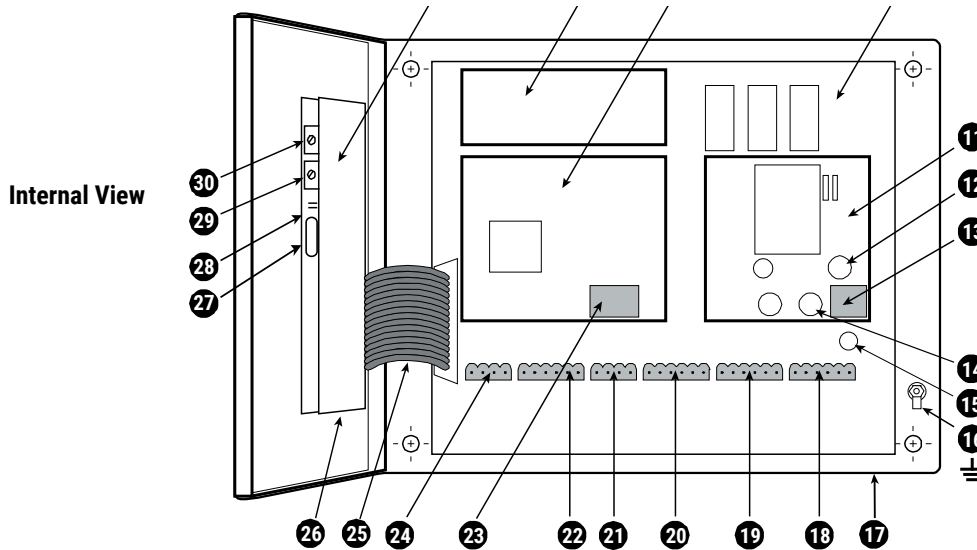

INTERNAL VIEW

INTERNAL VIEW

- | | | | |
|--|---|--|---|
| 7 User interface (UI) board | 14 Voltage selector
110/220 volts | 20 Service relay terminals
(removable) | 24 RS-485 TT-SIM network
terminals (removable) |
| 8 4-20 mA board (optional) | 15 Spare fuse | 21 4-20 mA port terminals
(removable) | 25 Ribbon cable |
| 9 Sensor Interface (SI)
board | 16 Ground (earth) stud | 22 RS-232/485 external
communications
serial port terminals
(removable) | 26 RS485/232 toggle switch |
| 10 Motherboard (MB) | 17 Gland plate | 23 Sensing cable terminals
(removable) | 27 Test Port (DB-9 connector
for temporary connection) |
| 11 Power supply board | 18 Fault relay terminals
(removable) | | 28 Reset pins |
| 12 Fuse (500 mA, 250 V) | 19 Leak relay terminals
(removable) | | 29 Volume adjustment |
| 13 Power cable terminal
block (removable) | | | 30 LCD contrast adjustment |

THE TTDM-128 KEYPAD

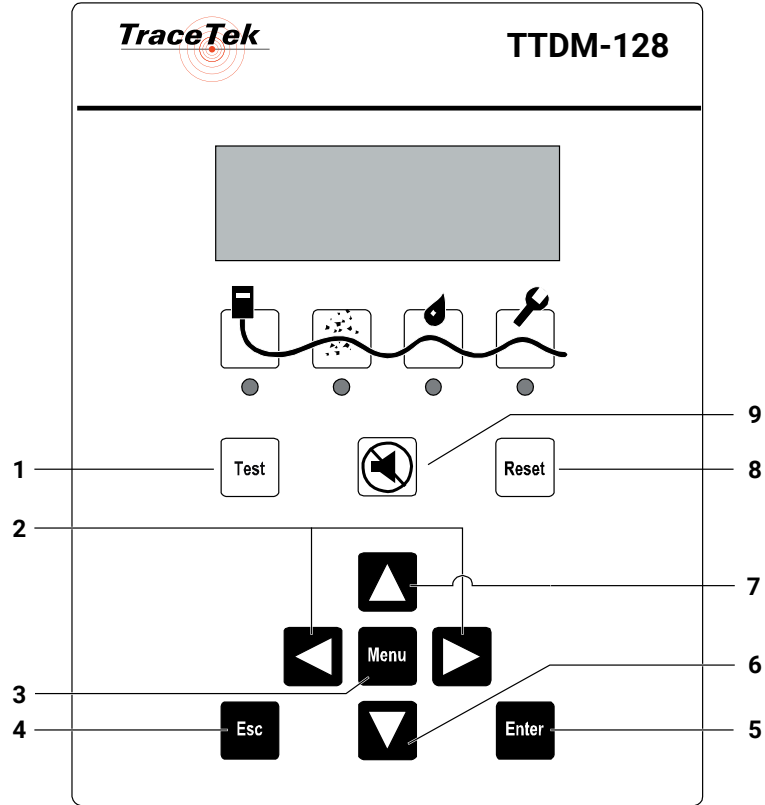

- 1. Test** Activates limited series of self-tests; additional self-tests are accessed through the menu (see Self-Test section).
- 2. Left/Right arrow** In Current Events/Status display, manually select the channel displayed. When inputting numbers or text, select digit to change. In menus, act as express keys for going to the top or bottom of long scrolled lists.
- 3. Menu** Accesses menu of display and set-up options (see “Navigating the Menu Structure”).
- 4. Esc** Goes back (up) one level in menu structure.
Hint: Pressing **Esc** multiple times returns to the Current Events/Status display. From most menus, pressing **MENU** also returns to the Current Events/Status display.
- 5. Enter** Selects a menu option or enter a user supplied value.
- 6. Down arrow** In Current Events/Status display, accesses detailed System Status information for the channel currently displayed. In menu selections, scrolls down through displays and menu options. Change (decrease) digits or alpha characters when entering user supplied values.
- 7. Up arrow** Scrolls up in status displays and menu options. Change (increase) digits or alpha characters when entering user supplied values.
- 8. Reset** Resets the Leak alarm relay, including TTSIM-1A and TTSIM-2 relays and TT-NRM relays.
- 9. Silence** Silences the audible alarm.



THE TTDM-128 SYSTEM DISPLAY

The icons represent the four conditions of the leak detection network. The LEDs indicate which conditions are currently active.

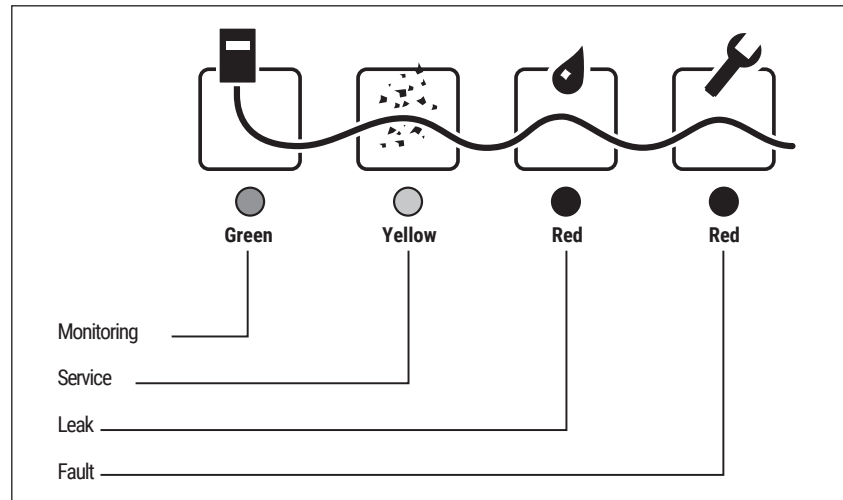

IMPORTANT: The Service, Leak and Fault LEDs will illuminate if an alarm condition exists on any SIM. Multiple LEDs may be illuminated simultaneously to indicate multiple types of alarms, although the alarms could exist on different SIM channels.

MONITORING



The green LED indicates that the TTDM-128 is powered up.

SERVICE



The TTDM-128 is able to give advance warning of potential problems. The yellow Service LED illuminates to indicate that service is required on one of the sensing cables attached to the network. Note that the green Monitoring LED remains illuminated; the unit continues to monitor for leaks during a Service alarm.

LEAK



When liquid is detected, the red Leak LED illuminates. Note that the green LED remains illuminated; the unit continues to monitor for new leaks on all channels, as well as for changes to the detected leak.

FAULT



When the TTDM-128 module detects a fault — either a cable fault (break) or an electronics fault — the red Fault LED illuminates. After a fault on an individual SIM has been detected, the TTDM-128 module will, in most cases, continue to scan the remaining SIM units and their associated sensing circuits. However, some fault conditions may disable multiple channels or even the entire system. The TTDM-128 is unable to detect a leak on any channel affected by a fault.



IMPORTANT: Always investigate the cause of a Fault condition immediately.



IMPORTANT: For more information on the various TTDM-128 alarm states, see the Event Response section.

CURRENT EVENT/STATUS DISPLAY

A representation of the Current Event/Status Display screen is shown below.

Line 1	CH01 SERVER ROOM
Line 2	LEAK 125 M
Line 3	
Line 4	12 :30 21-01-2003

A guideline for the Current Event/Status Display is shown below.

Line 1	identifies the channel currently displayed, showing the SIM channel number and user-defined ID tag (up to 14 characters). For a new system, the default label is SIM until edited by the user.
Line 2	indicates the current status of the SIM channel identified on Line 1, or In the case of Leak re-alarm, displays the initial leak location of the SIM channel identified on Line 1.
Line 3	may advise action or provide special instructions, or in the case of leak re-alarm, indicates the current status of the SIM channel identified on Line 1.
Line 4	displays the current time (in 24 hour format) and date; the colon blinks once a second, or in the case of Leak re-alarm may advise action or provide special instructions.

The LCD display is a backlit 4-line by 20-character display. If there is no activity for several minutes, the back lighting turns off, until any key is pressed.

HINT: The LCD contrast may be adjusted (feature 30 in the TTDM-128 Internal View diagram).

If no new alarm conditions exist, the LCD display scrolls through each connected SIM channel in sequence. The LCD presents the current event/status display for each channel for about 4 seconds, then continues to the next connected SIM channel. Once the last SIM channel is displayed, the process starts again at the first channel.

If the TTDM-128 detects a new Service, Fault, or Leak event, it immediately changes the display to the SIM channel affected, turns on the LCD back light, and pauses at that channel. After several minutes, or after any key is pressed, the scrolling process starts again.



IMPORTANT: Use the left and right arrow keys to manually change to another SIM channel.

NAVIGATING THE MENU STRUCTURE

Please refer to the Main Menu Structure and SIM Status Menu Structure diagrams for an overview of the TTDM-128 menu structure. The TTDM-128 keypad is used for navigation as described below:

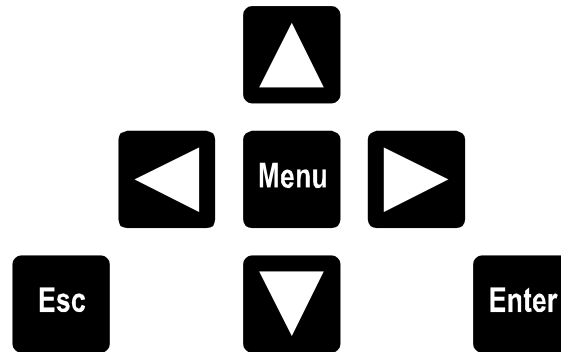

From the Current Event/Status display screen:

- Press the **LEFT** and **RIGHT** arrow keys to manually select the SIM channel of interest.
- Press the **DOWN** arrow key to access detailed status information for the SIM channel currently displayed. See the SIM Status Menu section for more information.
- Press the **MENU** key to access the many display and setup features in the TTDM-128 per the main menu. See the Main Menu section for more information.
- Use **UP** and **DOWN** arrow keys to scroll through menu options and status displays.
- Use the **LEFT** and **RIGHT** arrow keys to select individual characters when entering data.
- Press **ENTER** to make a selection or go one level deeper into the menu structure.
- Press **ESC** to go back (up) one level in the menu structure.

 **IMPORTANT:** If the TTDM-128 is left in a menu display with no keypad activity for 30 minutes, automatically returns to the Current Event/Status display.

MAIN MENU STRUCTURE

Current Event/Status Display

Menu

--- Main Menu

- Events History
- System Status
 - SIM Network
 - 1..current status
 - 2..current status
 - #...
 - NRM Network
 - 1..current status
 - 2..current status
 - #...
 - Leak
 - Service Req'd
 - Faults
 - Cable
 - SI Comm/Other
 - NRM Comm Error
 - UI Version
 - TTDM

- General Setup
 - Time/Date
 - Language
 - English
 - Francais
 - Deutsch
 - Espanol
 - Italiano
 - Japanese
 - Password
 - **Special**

- Leak Setup
 - ReAlarm Int
 - Auto Reset
 - Audible Alarm
 - Alarm Reflash
 - Alarm Reset

- SIM Network
 - Set SIM Address
 - Init Network
 - Update Network

TTDM Network

- Baud
 - 38400
 - 19200
 - 9600 (default)
 - 4800
 - 2400
 - 1200
 - 600
- Modem
 - Auto Answer
 - Dial
 - Hang up
- 485 Address (default 1 Hex)
- TTDM
 - **Auto**
 - **RTU only**
 - **iServer**
 - **Remote TTDM**
- Terminal
- Print Events

--- Self-Test

- UI Version
- Memory Tests
- SI Test
- 4-20 mA Test
- Display Test
- UI Relay Test
- Keypad Test
- Ext Comm Loop Test
- NRM Relay Test
- Ground Fault Test
(TTSIM-1 only)

SIM STATUS MENU STRUCTURE

Current Event/Status Display



- SIM Status
 - SIM Address
 - |--- *select different SIM*
 - ID SIM
 - |--- *change SIM ID*
 - *current status*
 - |--- *last alarm value*
 - TestLength
 - feet
 - metres
 - zones
 - Sense Cur
 - |--- Location
 - |--- Loc Res
 - Serv Alert >=
 - |--- **Set Service Alert**
 - **Normal (50 uA)**
 - **High (20 uA)**
 - **Low (80 uA)**
 - **TT500x (40 uA)**
 - **Never**
 - Sense Res
 - Leak Alarm <=
 - |--- **Set Leak Alarm**
 - **Normal (18 kΩ)**
 - **High (30 kΩ)**
 - **Low (14 kΩ)**
 - **TT500x (10 kΩ)**
 - R-G Res
 - Y-B Res
 - SI Version
 - SI Comm

Add Regions/Relays

- Region #
 - Start
 - End
 - Id
 - Region Relay
 - Trouble Relay
 - Service Relay
 - SIM Relay
 - Alarm Mode
 - Leak
 - Leak/Brk
 - Alarm State
 - OFF
 - ON
 - Relay Reset
 - Auto
 - Manual
 - Safe
- } useable only if NRM installed
(only appears for TTSIM-1A / TTSIM-2)

Legend:
 normal text = menu item
italic text = variable data
bold text = password required

SIM STATUS MENU

The TTDM-128 offers access to detailed real-time status information for each SIM channel. The status display for an individual SIM channel is accessed from the Current Event/Status display:

- Use the **LEFT** or **RIGHT** arrow keys to select the SIM channel of interest.
- Press the **DOWN** arrow to access the detailed status information (as shown below) for the selected channel.

SIM Status	
SIM Address	<i>address</i>
ID	<i>user defined ID</i>
<i>SIM Status</i>	
TestLength	xxxx m
Sense Cur	xxx μ A
Serv Alert >=	xx μ A
Sense Res	xxxxx k Ω
Leak Alarm <=	xx k Ω
R-G Res	xxxxx Ω
Y-B Res	xxxxx Ω
SI Version	xxxx
SI Comm	xxx %
Add Regions/Relays	



IMPORTANT: Only four lines are displayed at one time. Arrows in the scroll bar indicate if other entries can be accessed with the up or down arrow keys.

MODIFYING SETTINGS FOR INDIVIDUAL SIM CHANNELS

A description of each line on the SIM Status Menu appears below:

SIM address

The SIM channel address number is displayed on the right side. If you want to go to a different SIM number, press the **ENTER** key to bring up a screen that allows you to enter the number of the different SIM, see below:

SIM Address: 001 000...127

Use the **LEFT** and **RIGHT** and **UP** and **DOWN** arrow keys to change the number. Press **ENTER** to move to the selected SIM.

If you enter a SIM number that is not connected to the TTDM-128, the following message is displayed:

SIM xx Not Found Press ESC to Exit

ID

This screen allows you to change the label assigned to the individual SIM channel. The alphanumeric label can be a maximum of 16 characters. The default ID is SIM.

ID: XXXXXXXXXXXXXXXXXX

Use the **LEFT** and **RIGHT** arrow keys to select a character position to change. Use the **UP** and **DOWN** arrows to cycle through all the available characters until the desired character is displayed. There are numerous special, Katakana, and non-English alphabetical characters available. Going "**UP**" or "**DOWN**" cycles through all available characters.

(**Tip:** Use the **RESET** key to "skip" between Letters, Numbers and blank). When the label is complete, press **ENTER** to save the changes, otherwise they will be lost.

SIM STATUS

The current status is displayed. Status can be either:

- Normal with location field blank
- Leak {with location displayed in ft/m/zones}
- Re-alarm [with location displayed in ft/m/zones]
- Service Required [with location displayed in ft/m/zones]
- Leak cleared
- Cable break
- Loop Break
- Loop Imbalance

An additional feature (Last Alarm Values file) is available from the SIM Status line. The Last Alarm Values file is particularly useful in evaluating transient problems. The specific cable parameters associated with the most recent alarm that has cleared are maintained in memory. The values are displayed by pressing the **ENTER** key. Example values associated with a simulated leak event are displayed below:

Last Alarm Values	
Leak	538 ft
Loc Res	2097 Ω
Sense Res	2 k Ω
R-G Res	4192 Ω
Y-B Res	4190 Ω

Press **Esc** to return to the SIM status screen.

TEST LENGTH

Test Length represents the total length of the sensing circuit attached to the SIM. Test Length does not change over time, it will stay the same unless the system is modified (sensing cable was removed or added).



IMPORTANT: The Test Length normally is about 1% longer the mapped length for the SIM channel.

The Test Length value is displayed on the right. If you want to change the units of length, hit the **ENTER** key to bring up the following screen. Use the **DOWN** arrow to select meters or zones. Press **ENTER** to select.

Units
feet
meters
zones

If you press **ENTER** to select zones, the screen below allows you to change the default zone value.

Set Zone Resistance	
Zone Res	200 Ω

To change the value, press **ENTER**. Password entry is required to change from the default value. After password entry this screen allows entry of a value between 180 and 300 ohms. Enter your new value as displayed on the top line of the screen below:

Zone Res:	200 Ω
	180...300

Use the **LEFT** and **RIGHT** and **UP** and **DOWN** arrow keys to change the number. Press **ENTER**. Press **Esc** to return to the SIM status screen.

SENSE CUR

The Sense Current (Sense Cur) measured value is shown on the right side of screen. This current (measured in μA) indicates the condition of the sensing cable.

In a clean leak-free sensing circuit, the Sense Current should be 0 μA .

If the Sense Current value is greater than 9 μA , press **ENTER** to display the calculated leakage location value for troubleshooting purposes. The Location value is displayed using the selected Units (either feet, meters, zones) along with the Location Resistance (Loc Res) value in ohms. Example values associated with a simulated event are displayed below:

Location	
Location	100 ft
Loc Res	390 Ω

If the Sense Cur rises to 20 μA or above, service is recommended-as it may indicate the presence of contamination on the sensing cable.

If a leak is detected, the current will rise to greater than 270 μA (depending on the type of TTSIM used).

Press **Esc** to return to the SIM status screen.

SERVICE ALERT

This setting controls Service Alerts. If Sense Cur is greater than the Service Alert setting, the TTDM-128 signals a Service Alert.

The proper setting for the Service Alert is based on the type of liquid leak being detected and the environment in which the sensing cable is located. Available settings include Normal, High, Low, TT500x or Never, per the guidelines below.

Normal is the default setting and is used for most applications.

High is used for de-ionized water applications.

Low is used for particularly active or exposed applications.

TT500x is used for hydrocarbon sensing cable applications (TT5000 series, TT5001 series).

Never is used to turn this feature OFF. It is not recommended to use the Never setting, because this disables the Service Alert. Service Alert is designed to maintain system performance.

Press **ENTER** to display the screen below:

Set Service Alert
Normal (50uA)
High (20uA)
Low (80uA)
TT500x (40uA)
Never

Password entry is required to change the value from the default value.

Use the **UP** or **DOWN** to move between the settings, and press **ENTER** to select the setting. Each SIM channel can have a different Service Alert setting if desired. Press **Esc** to return to the SIM status screen.

SENSE RES

The Sense Resistance (Sense Res) is measured between the sensor cable wires.

For a clean leak-free sensing circuit, the Sense Res value is typically more than 20,000 kΩ.

If the Sense Res value is greater than 62,000 kΩ, the display will show ----kΩ.

If the Sense Res value is decreasing, it may indicate a leak in progress.

During leak detection events, the Sense Res value will drop to less than 30 kΩ.

LEAK ALARM

This setting controls Leak Alarms. If Sense Res is less than the Leak Alarm setting, the TTDM-128 signals a Leak alarm.

The proper setting for the Leak Alarm is based on the type of liquid leak being detected and the environment in which the sensing cable is located. Allowable settings include Normal, High, Low or TT500x, per the guidelines below.

Normal is the default setting and is used for most applications.

High is used for de-ionized water applications.

Low is used for particularly active or exposed applications.

TT500x is used for hydrocarbon sensing cable applications (TT5000 series, TT5001 series).

Press **ENTER** to display the screen below:

Set Leak Alarm
Normal (18 kΩ)
High (30 kΩ)
Low (14 kΩ)
TT500x (10 kΩ)

Password entry is required to change the value from current value.

Use the **UP** or **DOWN** to move between the settings, and press **ENTER** to select the setting.

Each SIM channel can have a different Leak Alarm setting if desired.

Press **Esc** to return to the SIM status screen.

R-G RES

Y-B RES

These values are the measured resistances of the Red-Green and Yellow-Black loops in the TraceTek leak sensing circuit. If the R-G Res and Y-B Res value are significantly different from each other, the TTDM-128 will create a Loop Imbalance alarm. If either the R-G Res or Y-B Res value becomes very high, the TTDM-128 creates a Loop Break or Cable Break alarm. Loop imbalance and Loop Break alarms are typically associated with damage to sensing cable or connectors.

SI VERSION

This parameter indicates the software version operating in the SIM microprocessor.

SI COMM

This parameter indicates the success rate (in percent) for communications between the TTDM-128 and the SIM channel selected. SI Comm values below 98% may indicate a faulty cable connection or damaged RS-485 cable.

Press **Esc** to return to the SIM status screen.

ADD REGIONS/RELAYS

This menu item accesses a submenu that lets the user divide a length of sensing cable (associated with an individual SIM channel) into as many as 10 smaller logical sections (Regions) and assign Labels or Relays to those Regions. Dividing a length of sensing cable into labeled regions can help identify the location of an alarm condition. By assigning relays to regions, it is also possible to create a wide range of alarm actions depending on the region and sensor cable condition.

Press **ENTER** to display the screen. A simulated screen is shown below:

Regions/Relays	
Region #	1
Start	1 ft
End	1 ft
ID	
Region Relay	----
Trouble Relay	----
Service Relay	----

SETTING UP REGIONS AND RELAYS

For some systems, it may be helpful to divide a circuit of sensing cable into regions. In addition, regions are sometimes useful in setting up TT-NRM relay actions.

When a length of sensing cable is divided into regions, the TTDM-128 will identify the region in which a Service or Leak event occurs. Each region represents a section of the entire length of sensing cable. Regions are defined by a Start (starting distance) and an End (ending distance). Regions can contain the entire sensing circuit, or only a part of the circuit.

To create regions for a circuit (repeat for each desired region):

- Select the appropriate SIM channel.
- Use the **DOWN** arrow key to select Add Regions/Relays, then press **ENTER**.
- Select Region No. from the menu and press **ENTER**.
- Use the arrow keys to select a region (1-10) and press **ENTER**.
- Select Start from the menu and press **ENTER**. This value represents the starting distance for the region. Using the arrows, enter a starting distance and press **ENTER**.
- Select End from the menu and press **ENTER**. This value represents the ending distance for the region. Using the arrows, enter an end distance and press **ENTER**.
- Select ID from the menu and press **ENTER**. Using the arrows, assign the region an alphanumeric label and press **ENTER**.

If a TT-NRM is connected and will be utilized with this region, continue as follows.

- **IMPORTANT:** Each TT-NRM leak alarm relay can only be assigned to a single region.
- Select Region Relay and press **ENTER**.
- Using the arrows, assign the relay to be activated for a Leak Alarm. Press **ENTER**.

If a TT-NRM is connected, continue as follows to assign the trouble relay and service relay.

 **IMPORTANT:** Trouble and service relays are not region specific. They will alarm for any point in the SIM circuit. Assign any unused relay to serve as the trouble relay. Assign a different unused relay to serve as the service relay.

- Select Trouble Relay and press **ENTER**.
- Using the arrows, assign the relay to be used as the Trouble Relay
- Select Service Relay and press Enter.
- Using the arrows, assign the relay to be used for the Service Relay

Region setup example:

Region No.	1	2	3	4
Start	0 m	251 m	501 m	751 m
End	250 m	500 m	750 m	1,000 m
ID	Room A	Hall	Room C	Room D
Region relay	50-01	50-02	50-03	50-04
Trouble relay	50-06	50-06	50-06	50-06
Service relay	50-07	50-07	50-07	50-07

SIM RELAY SETUP

If the SIM is a TTSIM-1A or TTSIM-2, continue as follows:

- Select SIM Relay and press **ENTER**.
- Select Alarm Mode and press **ENTER**. Select Leak if you want the relay to activate only on leak alarm, or select Leak/Brk if you want the relay to activate for any sensor alarm condition, then press **ENTER**.
- Select Alarm State and press **ENTER**. Select OFF if you want the relay to be normally energized, then de-energized for alarms, or select ON if you want the relay to be normally de-energized, then energized for alarms. Press **ENTER**.
- Select Relay Reset and press **ENTER**. Select the appropriate reset mode, then press **ENTER**:
 - Auto: the relay will reset when the TTDM Reset key is pressed (regardless of the current alarm condition), or it will automatically reset when the alarm condition clears.
 - Manual: the relay will remain latched and reset only when the TTDM Reset key is pressed. The relay will reset regardless of the current alarm condition.
 - Safe: the relay will reset only when the alarm condition has been cleared and the TTDM **RESET** key is pressed.

 **IMPORTANT:** TTSIM-1A and TTSIM-2 relays will activate for any leak on the circuit, regardless of region definitions.

MAIN MENU

The following are the options presented at the Main Menu level:

- Events History
- System Status
- General Setup
- Leak Setup
- SIM Network
- TTDM Network
- Self-Test

Each of these menu options is described in detail on the following pages.

Entering a Password

When a user attempts to change a restricted setting, the TTDM-128 displays a password prompt. The factory default password is 00010 (to change the password, see General Set-up section). To enter the password, proceed as follows:

- Use the **LEFT** and **RIGHT** arrow keys to move to each digit.
- Use the **UP** and **DOWN** arrows to increase/decrease the selected number.
- Press **ENTER** when complete.



IMPORTANT: Once the password is entered, it remains in effect (allowing access) until the user exits the Main Menu and returns to the Current Event/Status display, or until there has been no keypad activity for approximately 30 minutes.

EVENTS HISTORY LOG

One extremely useful function provided by the TTDM-128 is the ability to record a series of events. The TTDM-128 module keeps track of a list of up to 2048 events (the first 2048 events are numbered; if 2048 events are already stored, the oldest event is discarded as a new event is recorded). Events in the events history log may be specific to one SIM channel or may refer to the TTDM itself (such as user interactions). For a full list of event types, please refer to "Appendix 1 - Events Glossary".

Accessing the Events History Log

- From the Current Events/Status display, press **MENU**
- Then press **ENTER** to select Events History.
- Use the **UP** and **DOWN** arrow keys to scroll through the events history log. The events will be displayed in chronological order, with the most recent event displayed first.
Hint: To quickly move to a view of the most recent event, press the **RIGHT** arrow key. To move to the oldest event, press the **LEFT** arrow key.

TYPICAL TTDM-128 EVENT DISPLAY

```
Event # xxxx
Alarm Silenced
HH:MM DD-MON-YYYY
```

TYPICAL SIM EVENT DISPLAY

```
Event #xxxx
CH01 USER_LABEL_0001
Leak 237 ft
HH:MM DD-MON-YYYY
```

An arrow at the bottom left-hand corner (pointing down) indicates that there are further events "below" (occurring before) the one being displayed.

SYSTEM STATUS

The TTDM-128 offers access to detailed real-time status information, and provides an overview of System Status conditions.

Access the System Status menu from the Main Menu. The System Status menu has the following sub menus:

- SIM Network
- NRM Network
- Leak
- Service Req'd
- Faults
- UI Version
- TTDM (operating mode)

SIM NETWORK

The total number of SIM's in the network is reported. If more information on the SIM status is desired, press the **ENTER** key. The displayed screen uses a single line to display the status for each SIM channel. The SIM channels are displayed in numerical order, starting with the lowest number. Use the **UP/DOWN** arrow keys to move from one SIM channel to the next. If more information is desired about a specific SIM channel, press the **ENTER** key. The SIM Status screen (discussed in SIM Status section) is then displayed. Use the **DOWN** arrow key to access detailed SIM status information. Pressing the Esc key twice will return the System Status screen.

NRM NETWORK

The total number of NRM's (relays) in the network is reported. If more information on the NRM relay status is desired, press the **ENTER** key. The displayed screen uses a single line to display the status of an individual relay. The NRM relays are displayed in numerical order, starting with the lowest number. Use the **UP/DOWN** arrow keys to move from one NRM relay number to another. Pressing the **ESC** key once will return the System Status screen.

LEAK

The number of active Leaks is reported. Press the **ENTER** key to display all SIM channels with active leaks, and the associated leak distance.

SERVICE REQ'D

The number of active Service Req'd Alarms is reported. Press the **ENTER** key to display all SIM channels with active Service Req'd alarms, and the associated service distance.

FAULTS

The number of active Faults of all types is reported.

Press the **ENTER** key to display the number of current fault conditions related to:

- Cable
- SI Comm/Other
- NRM Comm Error

Use the **UP/DOWN** arrow key to select the specific fault type, then press the **ENTER** key to display more information about each individual fault of that type.

UI VERSION

The UI version is displayed

TTDM

The current operating mode of the TTDM-128 is displayed. The mode can be set by user, as described in TTDM Network section, as either:

- AUTO
- RTU only
- iServer
- Remote TTDM

GENERAL SET-UP

Access the General Set-up menu from the Main Menu. The General Set-up menu has the following sub menus:

- Time/Date
- Language
- Password
- Special (High level password required to see this menu)

TIME/DATE

Use the **LEFT** and **RIGHT** arrow keys to select each digit. Use the **UP/DOWN** arrow keys to increase or decrease the number. Press **ENTER** to save changes.

LANGUAGE

Select from available options (English, Français, Deutsch, Español, Italian and Japanese). Press **ENTER** to select.

PASSWORD

ENTERING A PASSWORD

When the user attempts to change a restricted setting, a password prompt appears.

- Use the **LEFT** and **RIGHT** arrow keys to move to each digit.
- Use the **UP** and **DOWN** arrow keys to increase or decrease the number.
- Press **ENTER** when complete.

The TTDM is supplied from the factory with the password 00010.

CHANGING THE PASSWORD

- Enter the old password if requested.
- Enter the new password (using the arrow keys) and press **ENTER**.

Hint: If password protection is not required, set the password to 00000. After that, you will not be prompted for a password.

SPECIAL

This mode is primarily intended for factory use only.

LEAK SETUP

The Leak Setup menu has the following submenus:

- ReAlarm Int (Re-Alarm Interval)
- Auto Reset
- AudibleAlarm
- Alarm Reflash
- Alarm Reset

These parameters determine the alarm setting for all SIMs. Password entry is required to change them.

RE-ALARM INTERVAL

The TTDM-128 can be set to re-alarm automatically if the alarmed event has not been cleared after a certain length of time.

- allowed range: 0 – 24 hours (default = 0, does not re-alarm)

Hint: You can use the Re-alarm interval capability to automatically alert the next shift when the system has an uncleared alarm (leak, cable break/fault, or service required).

AUTO RESET

The TTDM-128 is factory set to require a manual reset following a leak alarm. This allows the user to verify that any equipment connected to the Leak relay is ready to be switched back to its normal state. Note that this setting is independent from the TTSIM-1A/TTSIM-2 relay reset mode.

If Auto Reset is set to “On,” the leak relay will automatically reset as soon as the leak has been cleared.

- choices: Off / On (default: Off)

AUDIBLE ALARM

The audible alarm may be disabled if not required. Use feature 29 (on Internal View of TTDM-128 features diagram) to adjust the volume.

- choices: Off / On (default: On)

ALARM REFLASH

The alarm reflash option causes the leak alarm relay contacts to revert to their no-alarm state for approximately 5 seconds then return to the alarm state whenever an additional leak occurs before an existing leak is cleared. This is useful when a multi-channel system is connected to a host computer via a simple relay-only interface. Reflash will typically cause the host computer to log each new leak event as it occurs whether or not preceding events have been cleared.

- choices: Off / On (default: Off)

ALARM RESET

This parameter determines whether all SIM channels will be reset simultaneously when the Reset key is pressed (All setting), or only the currently displayed SIM channel will be reset (Single setting).

- choices: Single / All (default: Single)

SIM NETWORK

The SIM Network menu has the following submenus:

- Set SIM Address
- Init Network
- Update Network

SET SIM ADDRESS

This command allows the user to assign a new address to either the TTDM-128's internal SIM or an external TTSIM. This function is vital to starting up a new leak detection network. To assign an address to an external TTSIM, it must be connected to the TTDM-128 and able to communicate with it.



IMPORTANT: Be sure to assign a unique SIM address, or communications problems will result.

To set the TTDM-128 internal SIM or external TTSIM addresses, the SIM unit to be addressed must be set to the configure (CFG) mode. This is accomplished by placing a jumper on the CFG pins (J1 on the TTDM-128's internal SIM – see TTDM-128 Installation Instructions for details; refer to the appropriate TTSIM installation instructions for details regarding external TTSIM's). Note that only 1 TTDM-128 internal SIM or external TTSIM can be set to CFG at a time. After setting the address, you must remove the CFG jumper when prompted before proceeding to the next SIM unit.

TO ADD A NEW TTSIM TO THE LEAK DETECTION NETWORK AND ASSIGN IT AN ADDRESS

- Install and connect the TTSIM in accordance with the TTSIM Installation Instructions that accompanied it.
- Install the CFG jumper on the TTSIM.
- Press the **MENU** key to access the main menu.
- Select SIM Network and press **ENTER**.
- Select Set SIM Address and press **ENTER**.
- Use the arrow keys to set the new address to an unused address between 02 and 127 (note that address 01 is the factory default for the TTDM's internal SIM) and press **ENTER**.
- Remove the CFG jumper clip from the TTSIM, then press **Esc** twice on the TTDM.
- Repeat as necessary for each TTSIM added to the network.

TO ADD A NEW TT-NRM TO THE LEAK DETECTION NETWORK AND ASSIGN IT AN ADDRESS

- Install and connect the TT-NRM in accordance with the Installation Instructions that accompanied it.
- Using the switches on the TT-NRM base unit, select a unique address (see TT-NRM Installation Instructions). The address must not be used by any other device on the network.
- Power up the system and perform a network Update or Initialization (see INIT NETWORK and UPDATE NETWORK, in this section).
- Configure relay assignments (see SETTING UP REGIONS AND RELAYS in Modifying Settings for Individual SIM Channels section).

UPDATE NETWORK

Use this command to update the TraceTek network when TTDM-128, TTSIM or TT-NRM units have been added and assigned unique addresses (this is not necessary when TTSIM's are added and addressed using the TTDM Set SIM Address menu). When activated, this command immediately searches all unused addresses to determine what new equipment has been connected. The current event status of all devices will be maintained by this command.



IMPORTANT: Use the INIT NETWORK command to reset all current event status information.

- Select SIM Network and press **ENTER**.
- Select Update Network and press **ENTER**.

INIT NETWORK

Use this command to initialize the TraceTek network once all TTDM-128, TTSIM and TT-NRM units have been connected and assigned unique addresses. When activated, the Init Network command immediately searches all possible addresses to determine what equipment has been connected. The current event status of all devices will be reset by this command.



IMPORTANT: Use the Update Network command to add to an existing network without resetting the status of existing SIM's.

- Select SIM Network and press **ENTER**.
- Select Init Network and press **ENTER**.



IMPORTANT: For TTDM-128 networks, the TTDM-128 configured as the Remote device must be initialized or updated before the Master unit.

TTDM NETWORK

Access the TTDM Network menu through the Main Menu. The TTDM Network menu has the following submenus:

- Baud
- Modem
- 485 Address
- TTDM
- Terminal
- Print Events

These parameters affect only the serial port for external communications (features 22, 26 & 27 on the Internal View of TTDM-128 Features diagram). The first four submenus listed above require password entry.

BAUD

Use this option to select the baud rate of the external communications (host) serial port. Selectable values include 600, 1200, 2400, 4800, 9600, 19200 and 38400 Baud. Default is 9600.

MODEM

This menu item provides access to three submenus:

- Auto Answer causes a text string to be sent to the external serial port, which will set a Hayes compatible modem to auto answer mode.
- Dial allows the user to program an 11-digit numerical string into the menu.
- Hang-up allows the user to send a hang-up command to an external modem attached to the serial port.

485 ADDRESS

When more than one TTDM-128 is connected to a host computer on an RS-485 network, each TTDM-128 unit must be assigned a unique address. This menu allows the user to assign the TTDM-128 an RS-485 address (the default address is 1). An address of 1 through 20 hex can be selected, however, 20 should be reserved for testing only. Using addresses 1 through 1F hex allows as many as 31 TTDM's on one network.

TTDM

- **Auto**
This is the factory default and used for a TTDM installed by itself or installed as a master device for a group of TTSIM, TTDM, TT-NRM units. The TTDM will respond to Modbus polling from a Building Management System (BMS) or factory automation system. The TTDM will automatically recognize the type of Modbus (ASCII/RTU) and respond in kind to any request for data
- **RTU Only**
Some BMS systems poll at such a high rate that there is insufficient time for automatic protocol recognition at the TTDM. Setting RTU Only mode, disables automatic protocol decoding and speeds up the TTDM response. Use this setting only if the host system is polling exclusively in Modbus RTU mode.
- **iServer**
Select this mode if an external host system needs to access the network of TTSIMs directly. BMS systems usually poll data from the TTDM's internal data base. But some remote access devices (e.g. TT-iServer) need to access the TTSIM devices directly. iServer mode allows the host to request data from a TTSIM. In essence, the external device can 'poll through' the TTDM but at the cost of slightly longer response times.
- **Remote TTDM**
Use this setting for a TTDM that is to be monitored by a Master TTDM. This configuration is used when there are multiple TTDMs installed around a facility. A single TTDM can be installed as a Master display for the entire system. All other TTDMs should be set to Remote mode.

TERMINAL

Use this option to view a one-line display of characters being sent to or received from the TTDM external communications serial port. This function is used to verify communications during system start-up.

PRINT EVENTS

Use this menu selection to send an ASCII text message through the serial port to an attached serial device (either a directly connected PC running a terminal-emulation program, a serial printer, or a modem). This function allows the user to download all events in the Events History Log for later analysis. Do not use this when connected to a Modbus network, as it may disrupt communications.

SELF-TEST

The Self-Test menu provides access to specific user-selected test routines:

- UI Version
- Memory Tests
- SI Test
- 4-20 mA Test (see "Appendix 2 - Connection to Other Devices" for details)
 - Electronics Fault
 - SI Comm Error
 - Cable Break
 - Loop Imbalance
 - Service Req'd
 - System Normal
 - Leak (user selects location)
 - 20 mA Val (user selects location)
 - 4-20 mA SIM
- Display Test
- UI Relay Test (tests the TTDM's internal relays)
- Keypad Test
- Ext Comm Loop Test (see "Appendix 2 - Connection to Other Devices" for details)
- NRM Relay Test (tests the relays on any connected TT-NRMs)
- Ground Fault Test (only for External TT-SIM-1s)

The Self-Test menu is password-protected to prevent inadvertent emergency response activity, because in many installations the leak relay or 4-20 mA output may be connected to external systems. Always notify the appropriate response personnel before using the Relay Test or 4-20 mA Test to alter their outputs.

The first three tests are also accessed by pressing the Test key when the display is in the Current Event/Status Display mode. This key is not password protected.

EVENT RESPONSE

LEAK DETECTION AND LOCATION EVENTS

A LEAK ALARM

When liquid is detected by a sensor in any channel, the following occur:

- The audible alarm sounds (If audible alarms are not required, the module can be set to disable them - see Leak Setup section).
- The red Leak LED illuminates.
- The display changes to show the channel and location of the leak.

```
CH01 USER_LABEL_0001
Leak 504 m
hh:mm DD-MMM-YYYY
```

- The interfaces signal the event (Leak relay, 4-20 mA, and serial port)

The following actions should then be taken:

- Silence the alarm (if necessary).
- Locate the leak and clear the system.
- Reset the leak relay.
(This occurs automatically if Auto-Reset is enabled; see Leak Setup section.)

TO LOCATE THE LEAK

Using the channel number and location displayed by the TTDM-128, refer to the system map and determine where the leak was detected.

TO CLEAR THE SYSTEM

Fix the leak and clean up the area affected. Then clean and dry the sensing cable (in the case of TT1000 and TT1100-OHP and TT3000 and TT-FFS series) or replace the affected section (TT5000 series/TT5001 series and TT-7000-HUV). Once the sensing cable is clear, the module responds and the display changes:

```
CH01 USER_LABEL_0001
Leak Cleared
Press reset
hh:mm DD-MMM-YYYY
```

Notice that the red LED remains on. This indicates that the leak relay is still in the alarm state.

TO RESET THE LEAK RELAY

In order to reset the leak relay and return the module to the "SIM Normal" state, press the Reset button. Before doing so, check that any external equipment controlled by the leak relay is ready to be reset.

Once the **RESET** button is pressed, the relay returns to normal, the red Leak LED turns off, and the LCD returns to the normal display.

Hint: If manual reset is not required, the TTDM-128 can be set to auto-reset; see Leak Setup section.

SERVICE EVENTS

INTRODUCTION

A TraceTek sensing circuit consists of two electrical loops. The SIM module constantly monitors for current passing between loops. When the system is normal, there is no current passing between the loops.

When there is a leak on the system, the maximum current flows. If a SIM detects a lower but significant level of current flow between the loops, the TTDM-128 will signal a Service Alarm.

A low-level current could indicate one or more of the following:

- A very small leak (which may soon develop into a full leak alarm).
- Heavy condensation or small spills (coffee, tea, etc.) on a water or aqueous solutions sensing cable (nVent RAYCHEM TraceTek TT1000 and TT3000 for example).
- Conductive material on a water or aqueous solutions sensing cable. The material might be metal filings, concrete dust, flux, mastic, or other construction debris, or carbon-based dust from air-handling units, printers, or copiers.

While service alarms should be investigated, they do not disable the operation of the system. The TTDM-128 and TTSIM will continue to detect leaks during a service alarm. However, service alarms may affect the accuracy of leak location in certain cases.

THE SERVICE ALARM

When the TTDM-128 detects a condition requiring service (such as described above), it signals the event by taking the following actions:

- Sounds an intermittent beep.
- Illuminates the yellow Service LED.
- Switches the service relay to alarm state.
- Changes the LCD display to the following:

```
CH01 USER_LABEL_0001
Service Req'd [147]
hh:mm DD-MMM-YYYY
```

The number in square brackets indicates the estimated location of the material causing the alarm. The number is shown with square brackets to indicate that the value is only an estimate.

Hint: Because the cause (concrete dust, for example) of low-level current may be distributed over a long length of sensing cable, it is not always possible for the TTDM-128 to report a precise location. However, the indicated location is always a good point from which to begin a troubleshooting procedure.

The following actions should be taken:

- Silence the audible alarm.
- Clear the cable.



IMPORTANT: When the cable is cleared, the yellow Service LED, the alarm relay, and the LCD display will automatically return to their normal (non-alarm) state. No reset is required.

TO CLEAR THE CABLE

Investigate the cause of the alarm and conduct cleanup or maintenance accordingly.

Hint: If material causing a service alarm is spread throughout the system, it is often useful to subdivide the system; see INVESTIGATING LEAKS AND FAULTS in the Maintenance section for further information.

FAULT EVENTS

INTRODUCTION

Several conditions could lead to a fault alarm:

- A cable is disconnected.
- A cable is damaged.
- A connection is damaged.
- A specific SIM module is damaged.
- Communication is lost between the TTDM-128 and one or more SIM modules.

WHAT THE TTDM-128 MODULE DOES

The following shows how the alarm display would appear if the fault were caused by a broken or disconnected cable:

```
CH01 USER_LABEL_0001
Cable Break
hh:mm DD-MMM-YYYY
```

The TTDM-128 would display a different message for a different type of fault, such as a loop imbalance or loss of communication to a specific SIM module.

When a fault condition is detected, the following occur:

- An audible alarm sounds.
- The red Fault LED illuminates.
- The LCD displays a message appropriate to the fault condition.
- The interfaces signal the event (Fault relay, 4-20 mA, and serial port).

TO REMEDY THE PROBLEM

Find the problem and rectify it. This may mean reconnecting the cable, or finding the damaged section and replacing it. If the cause of the fault is not obvious by visual inspection, it is often useful to subdivide the system and test individual sections with a TraceTek Portable Test Box or DMM (digital multimeter).

As soon as the fault is cleared, the relay, LED, and LCD display return to their normal state.

MULTIPLE EVENTS

SIMULTANEOUS EVENTS ON DIFFERENT SIM CHANNELS

The TTDM-128 is capable of monitoring many sensing circuits. Each SIM operates independently of other SIMs in the leak detection network. The TTDM-128 tracks information for all SIM channels and is capable of handling multiple events that occur in the same time frame. Any new event takes precedence on the LCD display. The LCD display will pause temporarily on the most recent event, giving the local operator time to read the LCD message and take action. After pausing several minutes on the most recent event, the TTDM-128 display resumes automatic scrolling through each connected SIM channel.

At any time, the operator may manually select a channel by using the left or right arrow keys. When a channel has been selected manually, the display pauses on the selected channel for several seconds before scrolling resumes.

MULTIPLE EVENTS ON A SINGLE SIM CHANNEL

In some circumstances, multiple events may occur on a single SIM channel. The system continues to monitor during Service and Leak alarms, ensuring that the installation provides full-time protection. The TTDM-128 stores all events in memory, and in addition, updates the display based on the sequence of events in a SIM channel.

MOVING LEAK

The TTDM-128 will re-alarm when the leak moves more than the re-alarm distance, for which the default is 2 m (5 ft). The audible alarm will sound, the third line of the LCD will change, and a new event will be added to the Events History.

Example: suppose an initial leak is detected at 110 m. The TTDM-128 would display:

```
CH01 USER_LABEL_0001
Leak 110 m
hh:mm DD-MMM-YYYY
```

Suppose also that before repairs can be made, the leak spreads. Once the module has detected significant movement of the leak, the TTDM-128 module goes into alarm once again:

```
CH01 USER_LABEL_0001
Leak 110 m
Re-Alarm 115 m
hh:mm DD-MMM-YYYY
```

The LCD now displays the first leak (on the second line of the display) and the most recent alarm on the third line. The first leak recorded on the SIM channel is likely to be close to the source of the leak. The most recent leak shows the current “electrical center” of the liquid (essentially a weighted average). If the Re-Alarm location is relatively close to the first (as in the example above), it is likely that the leak has spread.

Should the leak continue to spread, the TTDM-128 would re-alarm again and the re-alarm location is updated accordingly:

```
CH01 USER_LABEL_0001
Leak 110 m
Re-Alarm 120 m
hh:mm DD-MMM-YYYY
```

Hint: Use the Events History to track the events between the “first leak” and the “most recent event.” See “The Events History Log” section.

ADDITIONAL LEAK

If liquid contacts sensing cable at a significant distance from the initial leak, the module will re-alarm, however it will indicate that this re-alarm leak distance could be caused by a new leak rather than a growing leak. In this case, the TTDM-128 shows the re-alarm location in square brackets:

```
CH01 USER_LABEL_0001
Leak 370 m
Re-Alarm [205]
hh:mm DD-MMM-YYYY
```

Brackets indicate that the value shown requires interpretation; when an additional leak occurs, the value represents the “electrical center” of the leaks.

SERVICE-TO-LEAK ALARM

Although the TTDM-128 and TTSIM system can continue to monitor a channel when a Service Required alarm is in effect, the accuracy of location may be impaired.

Example:

```
CH01 USER_LABEL_0001
Service Req'd [257]
hh:mm DD-MMM-YYYY
```

If sensing cable on that SIM channel detects a full-fledged leak before service is performed, the TTDM-128 displays a new leak alarm. If the location measured is nearly the same as the

earlier Service Required alarm, the display would appear as below:

```
CH01 USER_LABEL_0001  
Leak 257 m  
hh:mm DD-MMM-YYYY
```

If the leak location is different from the earlier Service Required alarm, the TTDM-128 shows a slightly different display:

```
CH01 USER_LABEL_0001  
Leak [190]  
hh:mm DD-MMM-YYYY
```

The TTDM-128 indicates the uncertainty about the leak location (due to the pre-existing Service Required alarm condition) by showing the location in brackets.

CLEANING THE TTDM-128 MODULE

To clean the outside surface, use a damp cloth or sponge. Do not use solvents or abrasive cleaners and do not open the enclosure while it is wet (it is an electrical device).

FUSE REPLACEMENT

The fuse on the power supply board of the TTDM-128 and TTSIM-1A and TTSIM-2 units is a 500-mA, 250-V, slow-acting microfuse. It has an T1 rating, characteristic code T (slow-acting). Use no other type of fuse or the TTDM-128 could be damaged or could fail to perform properly. One spare fuse is provided in the TTDM-128 (see feature 15 on Internal View of TTDM-128 Features diagram).

ROUTINE MAINTENANCE

It is recommended that the TraceTek Leak Detection system (including alarm modules and sensing cables/components) be thoroughly checked twice a year. Such a check will identify conditions that adversely affect the leak-locating capability of the system. More frequent checks may be required if the sensing cable is repeatedly exposed to leaks, or may be exposed to abuse due to construction or repair work. Contact your local TraceTek representative for further information on service support.

STORAGE AND HANDLING OF SENSING CABLE

Despite their rugged construction, TraceTek sensing cables must be handled in a manner appropriate for a sensing device or they may be damaged and require replacement. Therefore, you should follow some basic rules for storing and handling all TraceTek sensing cables:

- Store spare cable in its original container in a clean, dry place until ready for installation.
- Schedule cable installation after all mechanical, plumbing, and electrical work has been completed.
- Clean the area where the cable is to be installed, and remove any obvious debris or other sources of contamination.
- Do not solder or weld near the cable without providing protection from heat, solder flux, or weld splatter.
- Do not drop tools or floor tile on the cable; sharp or heavy objects may damage the cable.
- Avoid walking or stepping on the cable. Provide shielding (for example, a half shell of plastic pipe) where additional protection is necessary.
- Do not use tape to secure sensing cable (some tapes and adhesives absorb moisture) or use solvents that could eventually cause an alarm.
- Do not drag sensing cable through contaminants (such as pipe dope, PVC cement, solvents, oil, or dirt).

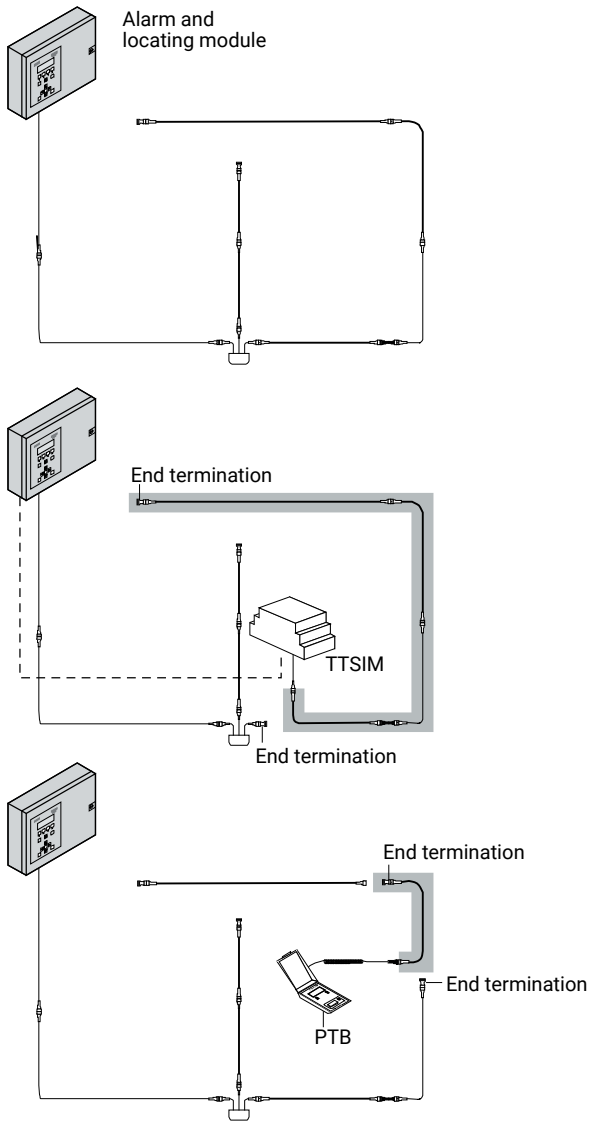

INVESTIGATING LEAKS AND FAULTS

If the location of a leak is not apparent, it is often useful to subdivide the leak detection circuit. To accomplish this, it is best to have a TraceTek Portable Test Box (PTB) or extra TTSIM, and an extra Modular End Termination. Contact your local TraceTek representative to obtain these products.

To subdivide the system and isolate the problems, find a connection at a convenient point somewhere near the center of the detection circuit. You can then use a PTB or add an additional TTSIM to test the “back half” of the sensing circuit (to verify circuit integrity, and to detect the presence of liquid and determine its location). If you install an end termination on the “front half” of the circuit (going back to the existing module), you can use that module to check the “front half” of the sensing circuit.

If you add a new TTSIM to the leak detection network (by connecting it to the RS-485 wiring connected to the TTDM-128), follow the Set SIM Address instructions, then perform an Update Network command (see SIM Network section). Examine the SIM Status of the new (“front half”) and old (“back half”) channels, and compare with the SIM Status of the former combined sensing circuit.

You can further subdivide the circuit, and even test individual lengths of cables. Even the most perplexing problems can usually be isolated and resolved using this methodical approach. If you wish to remove SIMs, remember to use the Init Network capability (see SIM Network section).

APPENDIX 1 - EVENTS GLOSSARY

Type of Event	Message	Description
Power	Power Down	The time the power was last supplied to the TTDM-128 is stored in nonvolatile memory and is entered into the Events History log when power is restored.
	Restart	The Events History log records when power is supplied to the unit or when the unit is manually restarted.
Leak	Leak	Liquid detected at the displayed channel and location.
	Re-Alarm	Occurs under three different situations: <ul style="list-style-type: none">• Location changed past Re-Alarm threshold.• New leak location is more than 8 m (25 ft) from the last stored location on the channel (new average is shown in brackets).• Automatic Re-Alarm after the Re-Alarm interval (a user setting) if the leak condition still exists.
	Leak Cleared	Displayed when channel status returns to normal after a leak is cleared.
	New Leak	A new leak on a channel is detected after an earlier leak is cleared but before the leak relay is Reset.
Fault	Cable Break	Loss of continuity in both loops of the sensing circuit. May be caused by broken or disconnected sensing cable, jumper cable, or connections.
	YB Loop Break	Break in the Yellow/Black loop of the sensing cable.
	RG Loop Break	Break in the Red/Green loop of the sensing cable.
	Loop Imbalance	Resistance of the two cable loops indicates more than 25% difference in measured resistance. May be early indication of cable deterioration or damage, or electrical contact of one sensing wire with a ground (earth) path.
	Cable Restored	Displayed when cable returns to normal after any fault condition.
	SI Comm Error	Communications problem between TTDM-128 unit and any installed SIM channel.
	SI Comm Recovered	Displayed when communication with SIM unit is re-established.
	SI H/W Error	A self-test of the SIM unit has failed. The unit needs to be repaired or replaced.
SI H/W Recovered	Displayed after a SIM hardware problem has been corrected.	
Service	Service Required	A small amount of current is flowing between the two sensing wires in the sensing cable. This is usually caused by a very small leak or buildup of contaminants. The TTDM-128 may indicate a location in brackets if it can obtain consistent measurements.
	Service Clear	Displayed when the condition requiring service has been cleared (for example, the sensing cable is clean and dry).
User Action	Settings Changed	Whenever any user-setup parameter is changed, the event is logged in the Event History.
	Alarm Silenced	User pressed the silence button.
	Reset	User pressed the reset button, or the system performed an automatic reset (if configured for Auto Reset).

APPENDIX 2 - CONNECTION TO OTHER DEVICES



IMPORTANT: All connections to external devices are made at the TTDM-128.

RELAYS

TTDM-128 has three relays: Service, Leak and Fault:

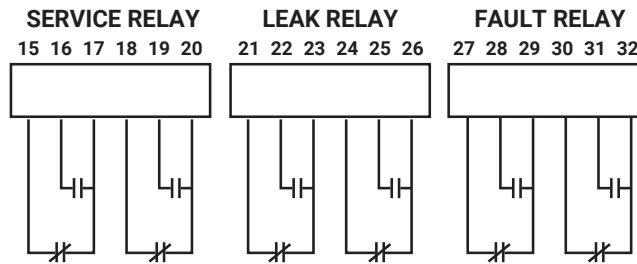

RELAY LOGIC

Each relay provides two Form-C relay contacts, with normally open and normally closed contacts both provided. The relays are de-energized to indicate an alarm condition. The diagram below shows the relay status when each is in an alarm (de-energized) state.

WIRING OPTIONS TO GANG ALARM RELAYS ON A SINGLE PAIR OF WIRES

The following illustrations show how the relays can be jumpered together to allow remote monitoring of the TTDM-128 system status with only a single pair of wires. The TTDM-128 de-energizes its relays to signal an alarm condition. Therefore, loss of power as well as any other type of alarm would trip the remote alarm.

Open on Alarm

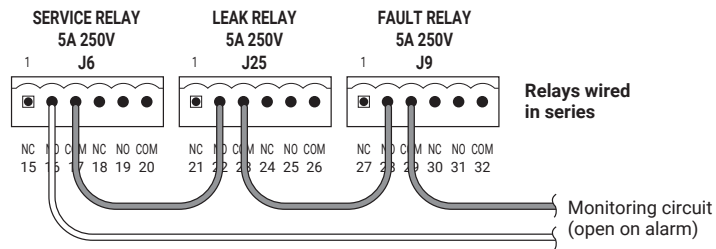

Close on Alarm

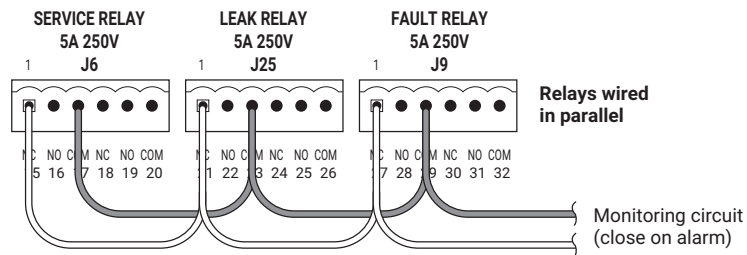

OPTIONAL 4-20 MA INTERFACE

The TTDM-128 can be equipped with an analog 4-20 mA interface which can communicate the status of a selected SIM channel. The TTDM-128 adjusts its current output based on whether an alarm condition exists in the selected channel, and (when a leak is detected) on the location of the leak.

The 4-20 mA current output is isolated from the sensing circuit and therefore requires an external DC power supply (26.4 V maximum). The maximum loop resistance (R_{max}) is determined according to the power supply voltage:

Vdc	Rmax
24	900 ohms
18	600 ohms
12	300 ohms

4-20 MA WIRING

Before wiring the external equipment to the TTDM-128, check that jumpers J11 and J12 "OPTION PCB INT PWR JMPRS" on the TTDM-128 Mother Board are **NOT** installed.

The 4-20 mA output port is connector J2 on the TTDM-128 motherboard. The external power supply and monitoring device can be connected as per either of the following diagrams:

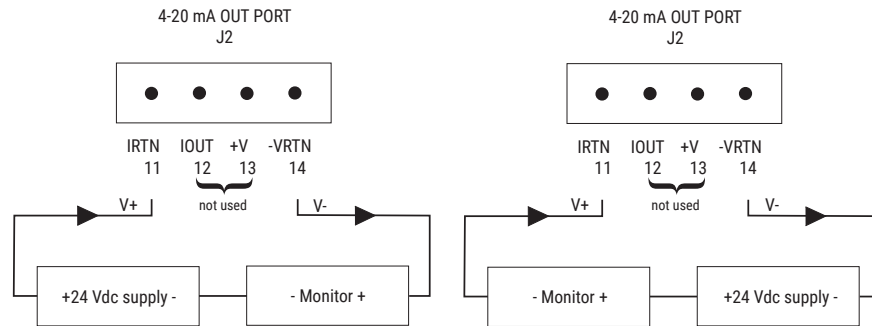

CONFIGURATION

The 4-20 mA interface communicates the status of a single SIM channel. The default SIM channel is the TTDM-128 internal Sensor Interface board (channel 1). The module's output can be scaled to provide maximum resolution of the 4-20 mA range for the length of sensing cable connected to the selected SIM channel.

To change the leak location scaling:

- From the Current Event/Status Display, press **MENU**.
- Use the **DOWN** arrow key to select Self Test, then press **ENTER**.
- Use the **DOWN** arrow key to select 4-20 mA Test, then press **ENTER**.
- Use the **DOWN** arrow key to select 20 mA Val, then press **ENTER**.
- Use the arrow keys to input the desired full scale length that will equate to a 20 mA output, then press **ENTER**. Normally this will be the Test Length value - see Status of Individual SIM Channels section.
- Press **MENU** to return to the Current Event/Status Display.

To use the port for a different SIM channel:

- From the Current Event/Status Display, press **MENU**.
- Use the **DOWN** arrow key to select Self Test, then press **ENTER**.
- Use the **DOWN** arrow key to select 4-20 mA Test, then press **ENTER**.
- Use the **RIGHT** arrow key to select 4-20 mA SIM, then press **ENTER**.
- Use the arrow keys to input the desired channel number that will be output by the 4-20 mA circuit, then press **ENTER**.
- Press **MENU** to return to the Current Event/Status Display.

INTERPRETING 4-20 MA OUTPUT VALUES

The TTDM-128 adjusts its current loop output based on the leak detection status of the selected SIM channel, as detailed in the table below. Outputs in the range of 0 to 4 mA are used to indicate fault conditions (0 to 3.5 mA) or normal operation (4 mA), while outputs in the 5 to 20 mA range indicate the location of a leak. The leak location values output by the 4-20 mA board have a resolution of 0.5% of the scale range.

Fault conditions coded into the 0-4 mA range:

Output (mA)	Description
0	Electronics fault or loss of power
1.0	Fault – SIM communications
2.0	Fault – cable break
3.0	Fault – cable damage
3.5	Service Required alarm (loop imbalance)

Normal condition and leaks:

Output (mA)	Description
4.0	System normal
5.0–20.0	Leak – value scaled to indicate location of leak

North America

Tel +1.800.545.6258
Fax +1.800.527.5703
thermal.info@nvent.com

Europe, Middle East, Africa

Tel +32.16.213.511
Fax +32.16.213.604
thermal.info@nvent.com

Asia Pacific

Tel +86.21.2412.1688
Fax +86.21.5426.3167
cn.thermal.info@nvent.com

Latin America

Tel +1.713.868.4800
Fax +1.713.868.2333
thermal.info@nvent.com



nVent.com